

Waters™

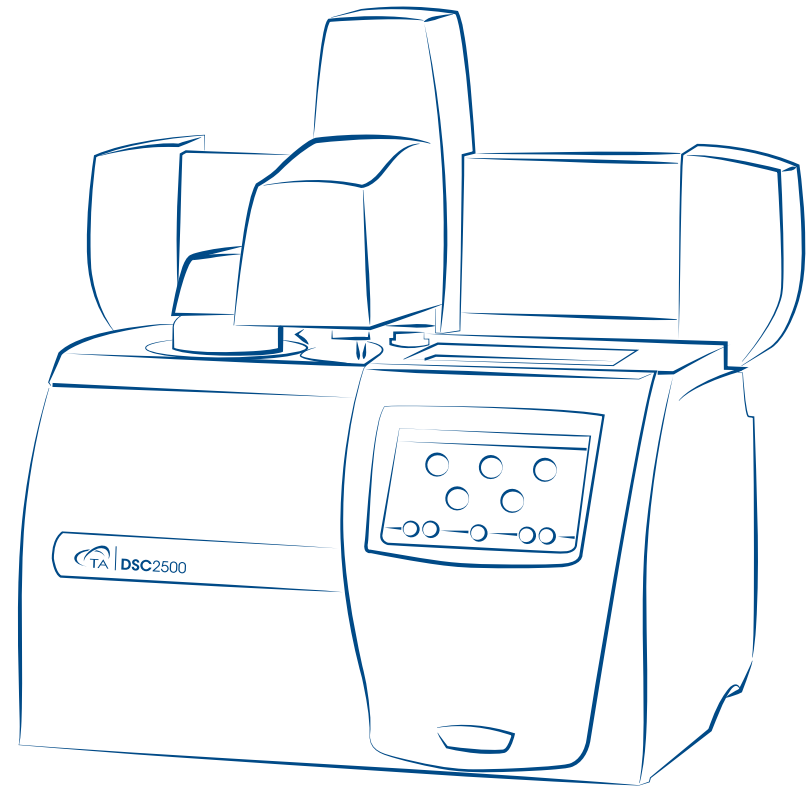

DISCOVER the
WORLD'S FINEST line of
DIFFERENTIAL SCANNING CALORIMETERS

**HIGH PERFORMANCE
DSC SYSTEMS**
that **deliver** the
Most Accuracy
Excellent Resolution
Highest Sensitivity
Greatest Reliability



DISCOVERY DSC | DIFFERENTIAL SCANNING CALORIMETRY



TA Instruments invites you to experience the world's finest line of Differential Scanning Calorimeters, the Discovery DSC 2500, DSC 250, DSC 25, and DSC 25P. Discover the advanced engineering and attention to detail that provides enhancements in every aspect of DSC technology and user experience.

From the most cost-effective DSC with industry-leading performance to the most advanced DSC available, there is a Discovery DSC to meet your needs and exceed your expectations.

Features and Benefits:

- Fusion Cell™ with patented technology provides unrivaled performance in baseline flatness, sensitivity, resolution, and reproducibility. Its superb technology enables detection of the weakest thermal transitions and the most accurate enthalpy and specific heat capacity.
- Exclusive Advanced T4P Tzero® heat flow technology for ultimate DSC performance has the unique capability to conduct and store heat capacity measurements in a single run.
- Modulated DSC® (MDSC®), for the most efficient separation of complex thermal events.
- One-Touch-Away™ User Interface, now standard on all Discovery DSC models, enhances usability and access to data on the instrument.
- Reliable linear autosampler with programmable tray positions for worry-free 24/7 operation, flexible programming of experiments, and automated calibration and verification routines.
- Widest range of refrigerated cooling options eliminates liquid nitrogen expense and ensures uninterrupted sub-ambient operation during extended autosampler routines.
- Tzero Press and pans for fast, simple, and reproducible sample preparation.
- Powerful software that delivers an exceptional user experience in a combined package for instrument control, data analysis, and reporting. Features such as automated calibration routines and real-time test method editing provide unmatched flexibility, while One-Click analysis and custom reporting raise productivity to new levels.
- Commitment to quality backed by the industry's ONLY five-year cell and furnace warranty for peace of mind.

TA Instruments has set the bar in the science of DSC where best-in-class performance is realized without the need for pre- and post-test data manipulation prevalent in competitive offerings. The Discovery DSC series provide both novice and advanced DSC users the highest confidence in generating superior data, while enhancing laboratory workflows and productivity.

DISCOVERY DSC | DIFFERENTIAL SCANNING CALORIMETRY

Understanding a material's structure–property relationship is necessary when designing, processing, and using a product. A range of thermal analysis techniques measure the physical properties of a material with respect to temperature, time, and atmosphere. The most prevalent thermal analysis technique—Differential Scanning Calorimetry (DSC)—measures endothermic and exothermic processes and is widely used to characterize a broad range of materials including polymers, pharmaceuticals, foods, biologicals, organic chemicals, and inorganic materials.

With DSC, easily measure thermal events such as the glass transition (T_g), melting, crystallization, cure reactions, onset of oxidation, and heats of transitions (enthalpy). Then expand upon the measurement of temperature and enthalpy to determine reaction kinetics, specific heat capacity, compatibility and stability of blends and alloys, effect of aging, impact of additives on crystallization, and much more.

The heat flux DSC consists of a single furnace in which the specimen and reference materials are heated or cooled together under a controlled temperature program. The sample is encapsulated in a pan (typically aluminum) and, along with an empty reference pan, sits on a thermoelectric disk surrounded by the furnace. As the furnace temperature is changed, typically at a constant rate, heat is transferred to the sample and reference. The differential heat flow to the sample and reference is measured by area thermocouples using the thermal equivalent of Ohm's law. A material's response in a DSC is best defined by the equation below, where the amplitude of heat flow is the sum total of a heat capacity component and kinetic component of the test material.

$$q = C_p (dT/dt) + f(T,t)$$

where: q = sample heat flow, C_p = sample specific heat capacity, dT/dt = heating rate, and $f(T,t)$ = kinetic response at a specific temperature, time.

The heat capacity component of the equation, $C_p (dT/dt)$, will express the specific heat capacity and changes in the heat capacity; this includes the glass transition observed in amorphous and semi-crystalline materials. Evaporation, cure reactions, crystallization, denaturation, and decomposition are expressed in the kinetic function, whereas, melting, a latent heat, is an endothermic enthalpy change and may be expressed as a sum total of both heat capacity and kinetic components within the melting temperature range of a material.

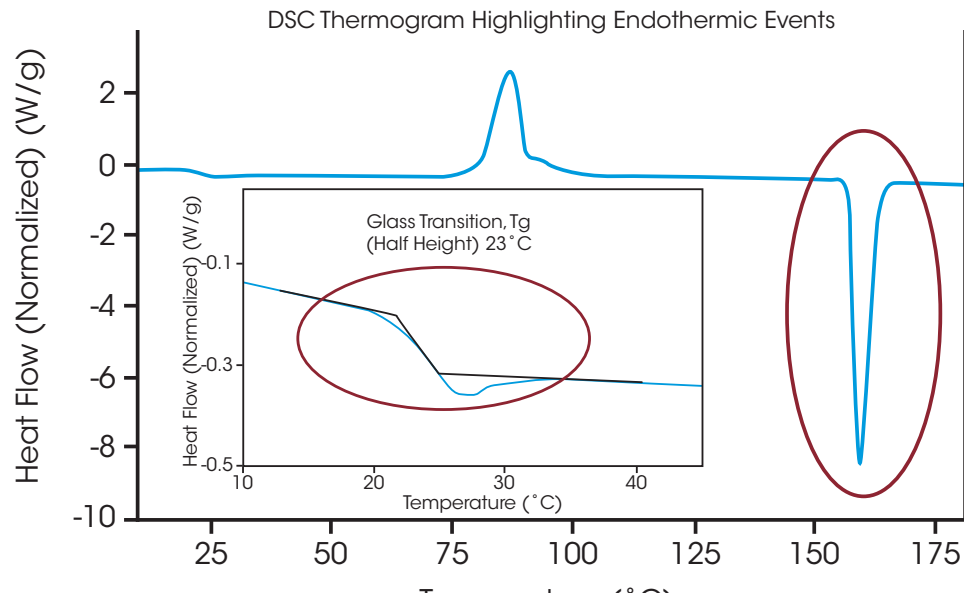

Endothermic Events

- Glass Transition
- Melting
- Evaporation/Volatilization
- Enthalpic Recovery
- Polymorphic Transitions
- Some Decompositions

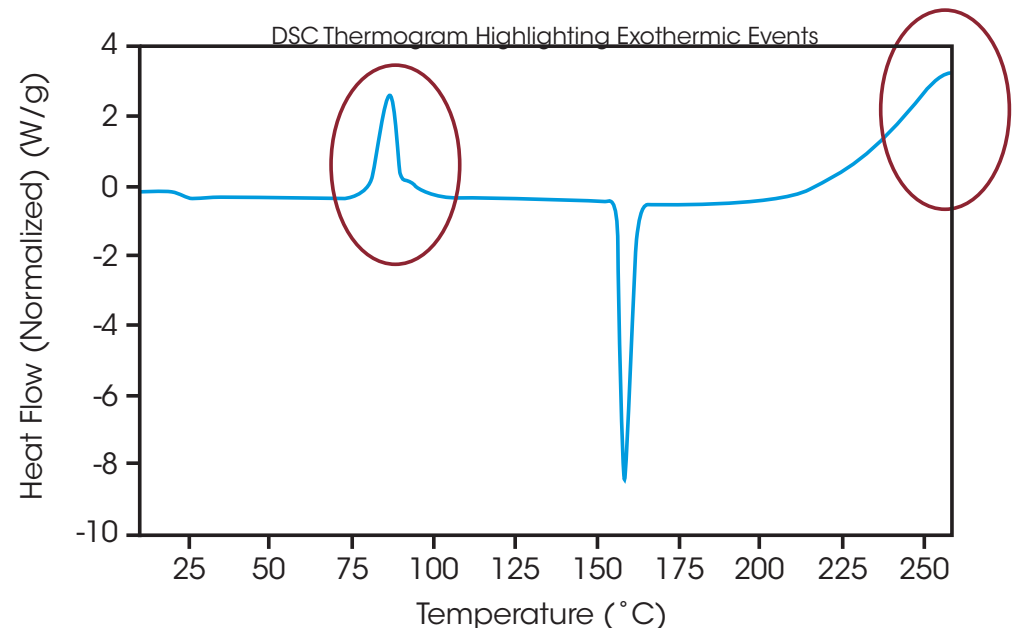

Exothermic Events

- Crystallization
- Cure Reactions
- Polymorphic Transitions
- Oxidation
- Decomposition



One Cell,
One Sensor,
Complete Performance

Fusi@nCell™

At the core of every Discovery DSC is the NEW TA Fusion Cell™, which incorporates design concepts that “FUSE” together the best features of the world’s bestselling Q Series™ and first generation Discovery DSC, patented Tzero® technology, and new proprietary manufacturing processes. Unlike competitive designs, the Discovery DSC delivers optimum performance with a single sensor, eliminating the need to exchange sensors to optimize a specific performance aspect. The result is an innovative new DSC with unrivaled performance in baseline flatness, sensitivity, resolution, and reproducibility.

FusionCell™ Features and Benefits:

- Patented Tzero technology measures the cell resistance and capacitance (ability to store energy) characteristics. It delivers a fundamentally more accurate heat flow measurement with incomparable baseline performance, while eliminating the need for baseline corrections prevalent in all other competitive offerings.
- Fixed pedestal-mounted sensor provides a stable configuration with a well-defined and reproducible heat flow path.
- Rugged uniblock silver furnace with long-life windings ensures superior temperature control and uniformity.
- Unique cooling rods and ring design produce superior cooling performance over a wide temperature range, higher cooling rates, and more responsive heating to cooling operation.
- Temperature-controlled electronics ensure the utmost in stability and repeatability of measured signals.
- Innovative gas delivery manifold provides gas switching and a consistent, repeatable atmosphere.

The Fusion Cell delivers the most absolute heat flow measurement possible. Additionally, lengthy pre- and post-test manipulations, such as baseline subtractions or de-smearing routines by required competitive designs, are never necessary.

TECHNOLOGY | TZERO® TECHNOLOGY

Traditionally, DSC heat flow measurements have been based on the principle that ASSUMES contributions by the sample and reference sensors to the total measured heat flow simply cancel each other out. If this assumption was true, all DSCs would have perfectly flat baselines. In reality, they do not. The fact is that each sensor's resistance and capacitance produce imbalances in the heat flow, resulting in deviations from baseline flatness and impaired resolution and sensitivity. ONLY TA Instruments, with patented Tzero Technology, can measure this imbalance. Tzero Technology® eliminates complicated pre- and post-test manipulations, such as baseline subtraction, deconvolution or other mathematical treatments competitive designs must use to improve baseline performance, sensitivity and resolution.

Patented Tzero Technology* measures the resistance and capacitance of the sensors and utilizes these values in the four-term heat flow equation to give the most accurate real-time determination of heat flow available on any DSC. TA engineers have taken this one step further by also including the contributions of the DSC pans. This advanced Tzero Technology, T4P heat flow, provides the sharpest resolution, the highest sensitivity, and allows for the measurement of heat capacity in a single run!

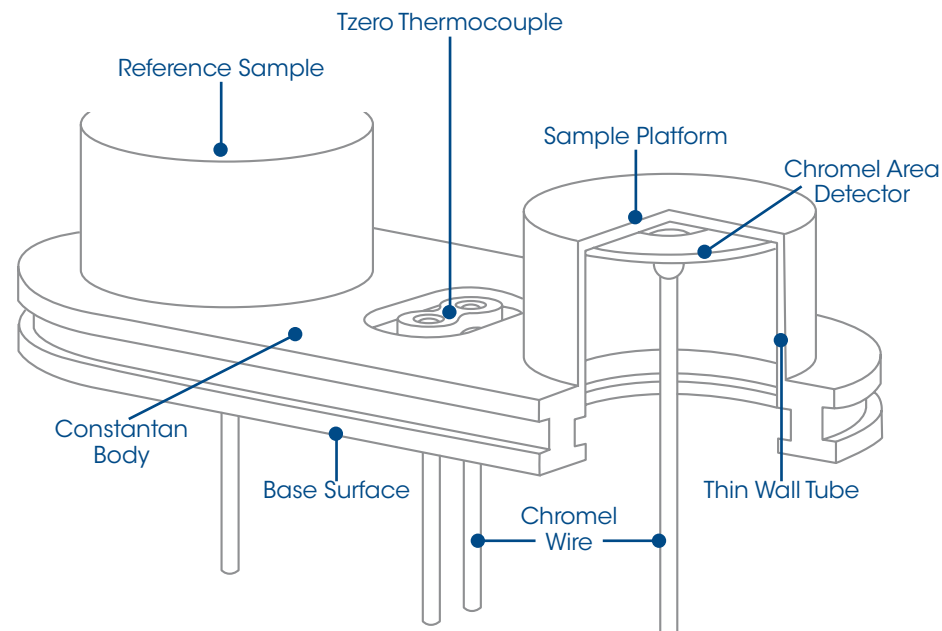

Tzero Heat Flow Equation

$$q = \underbrace{-\frac{\Delta T}{R_r}}_{\text{Competitive Measurement}} + \underbrace{\Delta T_0 \left(\frac{1}{R_s} - \frac{1}{R_r} \right)}_{\text{Thermal Resistance Imbalance}} + \underbrace{(C_r - C_s) \frac{dT_s}{dt}}_{\text{Thermal Capacitance Imbalance}} - \underbrace{C_r \frac{d\Delta T}{dt}}_{\text{Heating Rate Imbalance}}$$

Heat Flow Principal Heat Flow TA Measurement

*U.S. Patent No. 4,488,406 , 6,431,747 , 6,561,692

DISCOVER more Accurate Data with patented Tzero[®] Technology

Tzero Features and Benefits:

- Flattest baselines available of any DSC on the market, resulting in the most absolute data without manipulation or subtraction.
- Superb technology that enables detection of the weakest thermal transitions and the most accurate enthalpy and specific heat capacity.
- Highest resolution and sensitivity, without ever needing lengthy pre- and post-test manipulations as required by competitive designs.
- Direct determination of heat capacity in a single experiment.

By improving every aspect of performance, the Discovery DSC delivers data you can trust, in all applications, all the time.

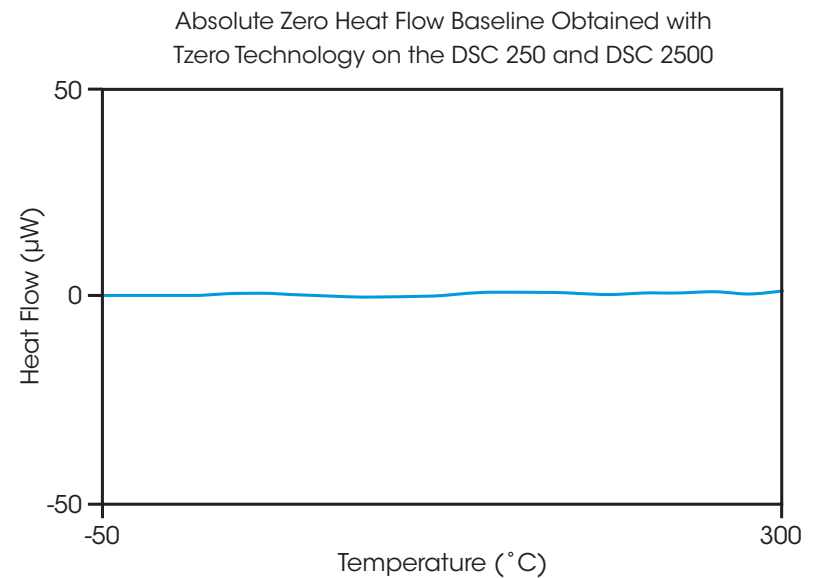
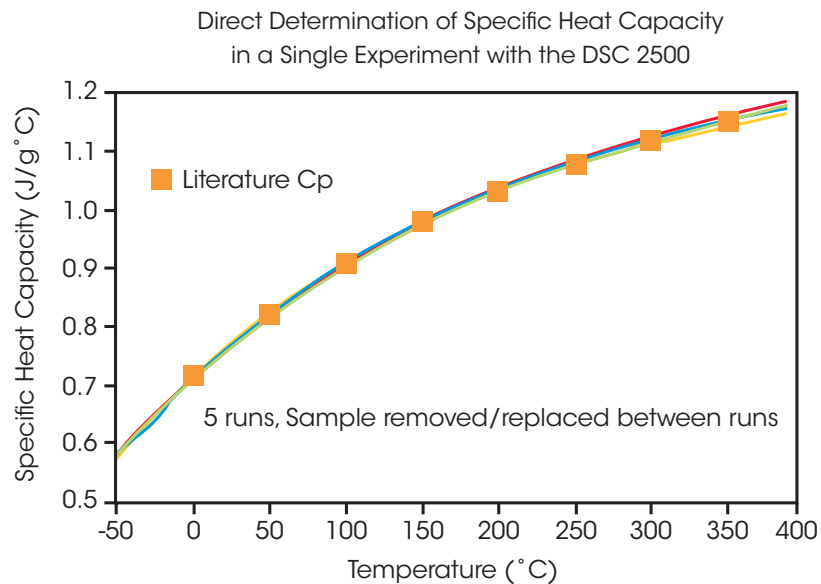

TECHNOLOGY | MODULATED DSC

Gain confidence in data interpretation with the help of MDSC®. Through deconvolution of the Total Heat Flow signal, events such as a glass transition masked under an evaporation peak, or the simultaneous occurrence of a cold crystallization with a melt, are easily revealed.

In TA's patented MDSC*, a sinusoidal temperature oscillation is overlaid on the traditional linear ramp. The net effect is that heat flow can be measured simultaneously with, and independently of, changes in heat capacity. The Total Heat Flow signal contains the sum of all thermal transitions, just as in standard DSC.

Modulated DSC separates the Total Heat Flow into the Reversing and Non-Reversing Heat Flow signals. The Reversing Heat Flow, comprised of the heat capacity component, contains glass transition and melting transitions, the Non-Reversing Heat Flow, the kinetic component, contains events like curing, volatilization, melting, and decomposition. TA invented MDSC and understands it like no other company. Modulated DSC is standard on EVERY Discovery DSC model.

$$q = \underbrace{C_p \left(\frac{dT}{dt} \right)}_{\text{Reversing Heat Flow}} + \underbrace{f(T,t)}_{\text{Non-Reversing Heat Flow}}$$

Features and Benefits of MDSC include:

- Separation of complex and overlapping transitions into more easily interpreted components.
- Increased sensitivity for detecting weak transitions.
- Increased resolution without loss of sensitivity.
- More accurate measurement of initial crystallinity.
- Direct determination of heat capacity.

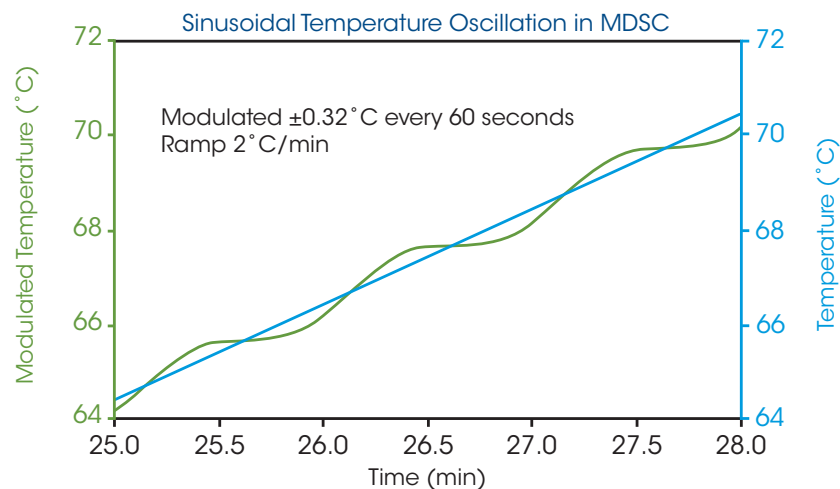

*U.S. Patent No. 6,561,692

DISCOVER more about your MATERIALS with MDSC®

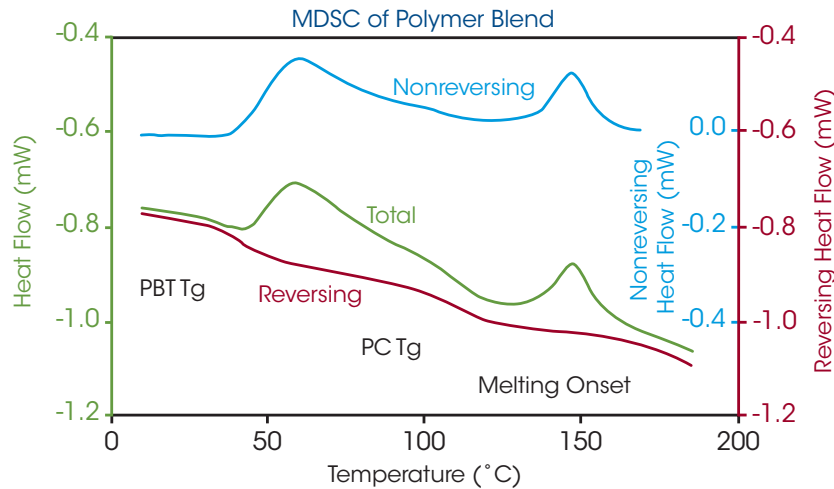

The plot shows MDSC results for a thermoplastic alloy blend of polycarbonate (PC) and polybutylene terephthalate (PBT). This material exhibits a variety of overlapping transitions, and interpretation of the Total Heat Flow is complicated. MDSC effectively separates the crystallization of the PBT component into the Non-Reversing Heat Flow, thereby allowing for accurate determination of the glass transition temperatures of each polymer in the Reversing Heat Flow.

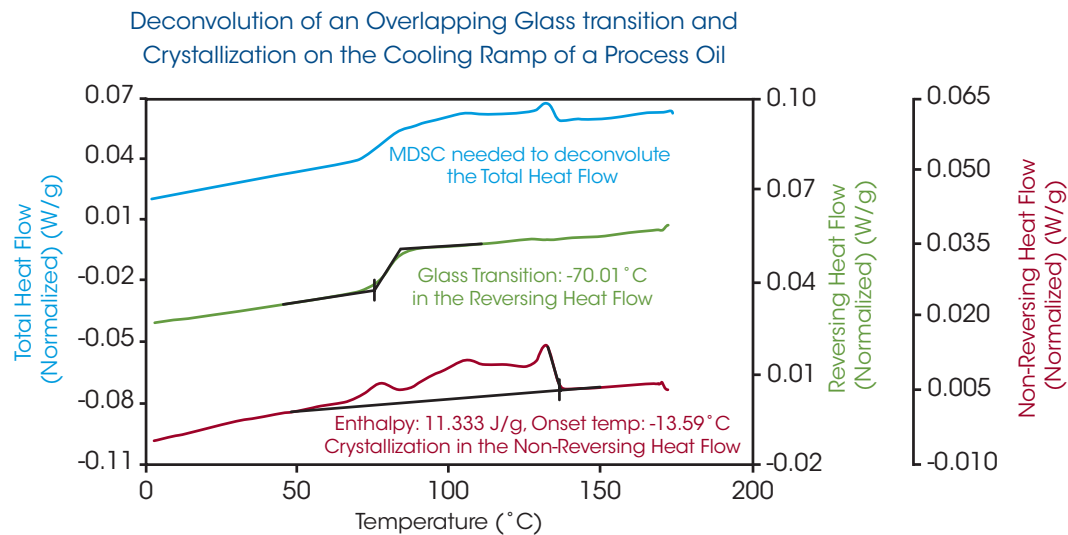

This process oil exhibits a variety of overlapping transitions making interpretation of the Total Heat Flow complicated. On the cooling ramp from 25 to -150°C, MDSC effectively separates crystallization into the Non-Reversing Heat Flow and the glass transition into the Reversing Heat Flow. Gain confidence in data interpretation with the help of MDSC!



It's hard to believe we could improve on the most reliable DSC autosampler on the market, but we did! The new linear autosampler was designed to be even more rugged and simple to use than ever before, while offering maximum testing flexibility.

Autosampler Features and Benefits:

- New Linear X-Y-Z design with integrated auto lid reduces sample loading time for increased throughput and reliability.
- The integrated auto lid gives consistent and repeatable cell closure, further improving the repeatability of measurements.
- New laser positioning system enables one-touch automatic calibration and pan location verification.
- Scheduled and unattended calibrations and verifications gives scientists more time for research.
- TRIOS software makes it easier than ever to manage and run a large and diverse sample queue. The Design view and Running queue allow for quick and efficient autosampler programming.
- Sample and reference pans may be assigned to any combination of the available 54 positions. Includes two quick-change trays for more convenient remote sample preparation.
- Convenient design allows you to unload pans back to the tray, or disposing of them, freeing space for continuous sample queuing.



TECHNOLOGY | "APP" STYLE TOUCH SCREEN



TA | DSC2500

Status: Idle

41.53 °C

SYSTEM INFO

SIGNALS

SETTINGS

Cell Flow
Temp
Heat Flow

Equilibrate
Ramp
Up

UTILITIES

AUTOSAMPLER

METHODS

Status: Test

SIGNALS CHART

Heat Flow
Temperature
Remaining Run Time
Purge Flow
Flange Temperature

-2.55mW
264.62°C
8.5 min
50 mL/min
-65.36°C



All Discovery DSCs feature TA's innovative touch screen, making operation easier than ever with enhanced One-Touch-Away™ functionality.



Touch Screen Features and Benefits:

- Ergonomic design for enhanced accessibility and productivity
- Packed with functionality to simplify instrument operation
- Resilient, responsive touchscreen for an enhanced user experience

The One-Touch-Away™ interface includes:

- Start/stop controls
- View active method
- Autosampler calibration
- System information
- Real-time signals and plot
- Advance to next step in method
- Load/unload pans
- Test and instrument status

Dramatically improve laboratory workflow and productivity with the One-Touch-Away™ interface, TA's powerful TRIOS software and the most robust, reliable DSC autosampler. These features enable automated calibration and verification routines that all work seamlessly for a simpler and more intuitive interaction.

TECHNOLOGY | TRIOS SOFTWARE

Discover powerful TRIOS software that delivers exceptional user experience in a combined package for instrument control, data analysis, and reporting for thermal analysis and rheology. New features such as multiple calibration sets, real-time test method editing, and inter-laboratory data and test method sharing provide unmatched flexibility, while One-Click analysis and custom reporting raise productivity to new levels.



TRIOS Features:

- Control multiple instruments with a single PC and software package
- Overlay and compare results across techniques including DSC, TGA, DMA, SDT and rheometers
- One-Click analysis for increased productivity
- Automated custom report generation including: experimental details, data plots and tables, control charts and analysis results
- Convenient data export to plain-text, CSV, XML, Excel®, Word®, PowerPoint®, and image formats
- Optional TRIOS Guardian with electronic signatures for audit trail and data integrity

Ease of Use

TRIOS software makes calibration and operation of the entire line of Differential Scanning Calorimeters simple. Users can easily generate multiple calibration data sets under varying experimental conditions (e.g. different heating rates or gas selections) and seamlessly switch between them to match the experimental conditions used for sample testing. Real-time signals and the progress of running experiments is readily available, with the added capability of modifying a running method on the fly. TRIOS software offers a level of flexibility that is unmatched in the industry.

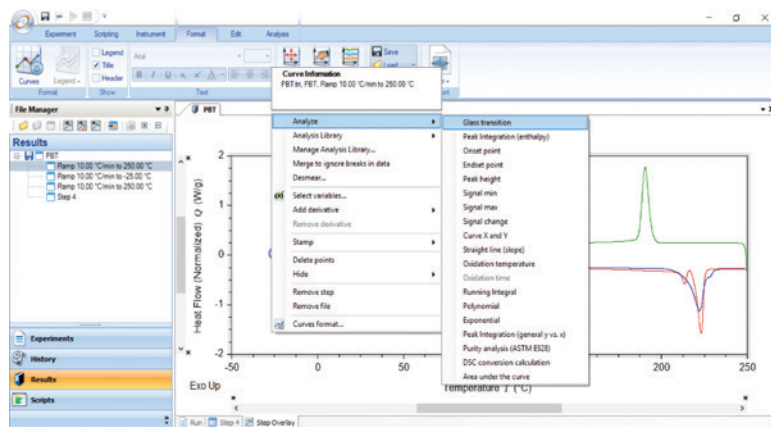

Complete Data Record

The advanced data collection system automatically saves all relevant signals, active calibrations, and system settings. This comprehensive set of information is invaluable for method development, procedure deployment and data validation.

The Most **VERSATILE CONTROL** and **ANALYSIS SOFTWARE!**

Complete Data Analysis Capabilities

A comprehensive set of relevant tools are available for real-time data analysis, even during experiments. Gain actionable insights into your material's behavior through a powerful and versatile set of features seamlessly integrated into TRIOS.

All Standard DSC Analyses:

- Glass transition, step change analysis
- Peak integration
- 1st and 2nd derivatives
- Oxidative onset temperature
- Oxidative induction time
- Purity
- Running integral and conversion
- Peak height and area
- Temperature at peak maximum
- Onset and endset analyses
- Easily import and export DSC data with TRIOS

Advanced Analysis Capabilities (Standard Features):

- Deconvolution of the Total Heat Flow signal with MDSC® into Reversing and Non-Reversing Heat Flow signal
- View captured images from the microscope accessory in TRIOS
- Advanced custom analysis and control charts with user-defined variables and models

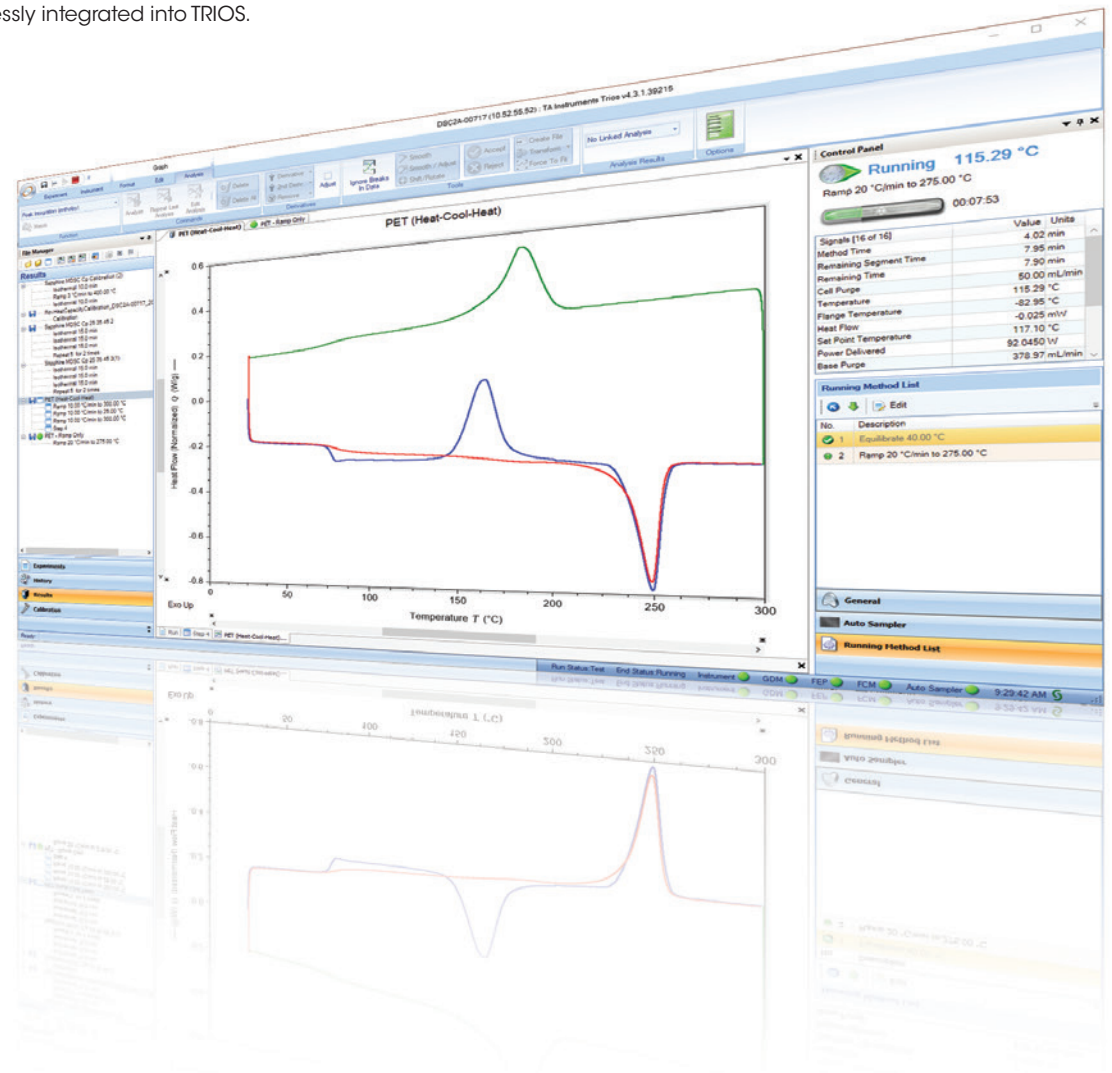

TRIOS EasyMass Software Feature for Differential Scanning Calorimeters (DSCs)

Streamlining Sample Preparation and Enhancing Accuracy

In the world of scientific research and quality control, precision and efficiency are paramount. The TRIOS Software for Differential Scanning Calorimeters (DSC) revolutionizes your laboratory workflow by seamlessly integrating your balance with the TRIOS Software. Learn more about how the TRIOS Software feature for can enhance your differential scanning calorimetry (DSC) tests:

1. Direct Electronic Mass Data Transfer Minimizes Errors

Bid farewell to manual transcription and calculation mishaps. TA Instruments TRIOS EasyMass Software enables direct digital transfer of mass data from the balance into TRIOS Software, improving accuracy and reliability..

2. Eliminate Pencil and Paper

Traditional sample preparation often involves scribbling measurements on paper. With our solution, you can go paperless, streamlining your workflow and reducing clutter with TRIOS EasyMass Software.

3. Boost Productivity with Seamless Integration

Repetitive tasks become a breeze. The TRIOS EasyMass Software seamlessly transfers data, allowing you to focus on higher-value work. No more wasted time on manual data entry.

4. Intuitive User Guidance

Step-by-Step Assistance: The TRIOS EasyMass Software display provides intuitive guidance, helping to ensure that essential data is captured accurately. New users will appreciate the reduced training time.

5. Streamlined Experiment Repetition

Immediate Sample Data Entry: After each TRIOS Software run, your sample data is automatically entered. Need to repeat the same method on multiple samples? It's as simple as a click, saving you valuable time.

6. Enhanced Review and Auditing

Automatic Data Entry Tied to TRIOS Software users: Facilitate second-person reviews and auditing effortlessly. The TRIOS EasyMass Software helps ensure that data is associated with the relevant TRIOS Software users, enhancing accountability and traceability.



TRIOS JSON Export Feature

Powerful human- and machine-readable data in an open standard

Unlock the power of your Differential Scanning Calorimeter (DSC) data with the TA Instruments™ TRIOS JSON Export Feature, designed to revolutionize data management and utilization. This powerful new capability seamlessly integrates TRIOS Software data with data science tools, automation workflows, and lab systems such as LIMS, making data handling more efficient and accessible than ever before.

Key Features:

- **Seamless Integration:** Convert your TRIOS data into the open standard JSON format, JSON is available:
 - Automatically on every save (enabled in options)
 - Through manual export dialogs
 - As part of the "Send to LIMS" functionality
 - Via the "Batch" processing dialog or from the command line
 - In TRIOS AutoPilot
- **Data Consistency:** Our publicly available JSON schema helps ensure a consistent data structure, allowing you to write code once and apply it almost universally across most of your data files.
- **Python Library:** Open-sourced Python Library, TA™ Data Kit (available at github.com/TA-Instruments/tadatakit), to simplify your data ingestion or learn how to take advantage of the power of our data with our code examples.

With the TRIOS JSON Export Feature, you're not just collecting data – you're unlocking its full potential. Experience streamlined workflows, reliable results, and a community-driven approach to Differential Scanning Calorimetry (DSC) analysis.

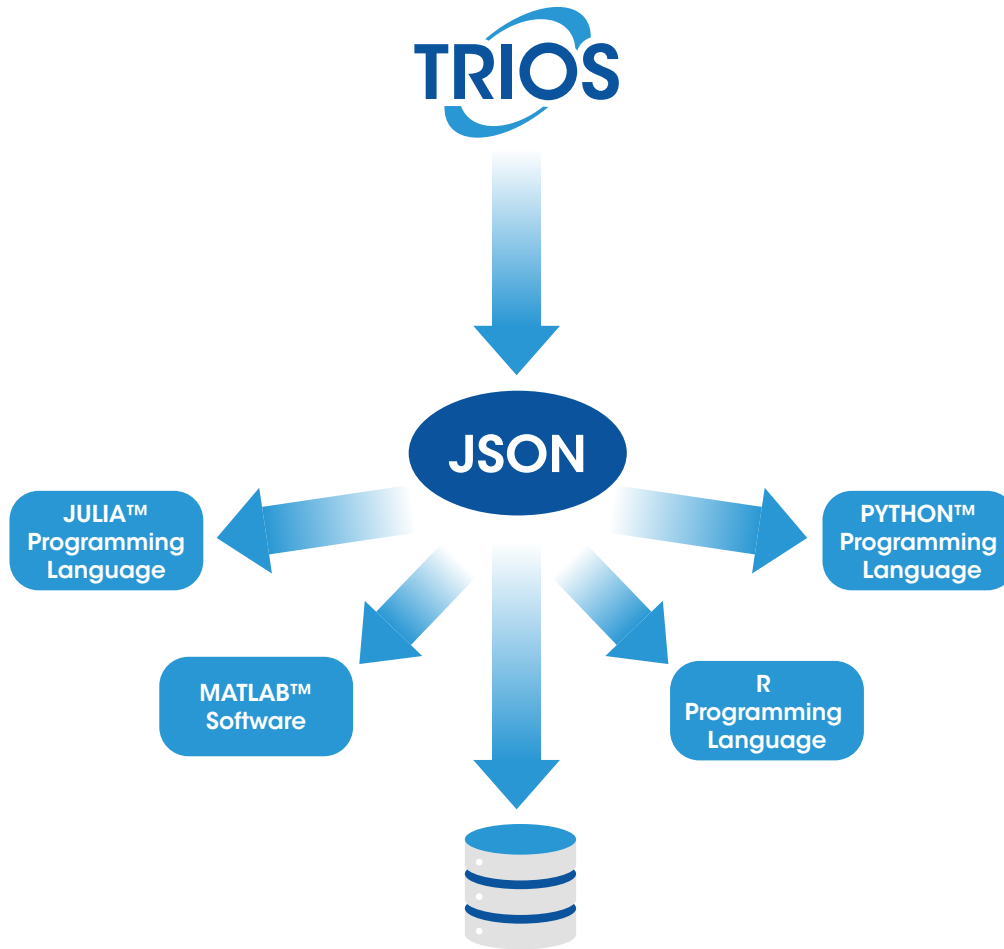

ACCESSORIES | COOLING SYSTEMS



Refrigerated Cooling Systems (RCS)

Take advantage of the convenient Refrigerated Cooling Systems (RCS) for unattended DSC and MDSC[®] operation over broad temperature ranges. The new RCS 120 provides enhanced safety and is the only liquid nitrogen-free system capable of conducting experiments down to -120°C.

RCS Features and Benefits:

- One-, Two-, or Three-stage refrigeration systems that achieve temperature ranges down to -40°C, -90°C or -120°C
- Sealed system eliminates the need for liquid nitrogen cooling
- Enables cycling, MDSC[®], controlled, and ballistic cooling experiments
- Safe, convenient, and continuous cooling operation for your laboratory needs

EXPLORE the full line of
**INTERCHANGEABLE
COOLING SYSTEMS**

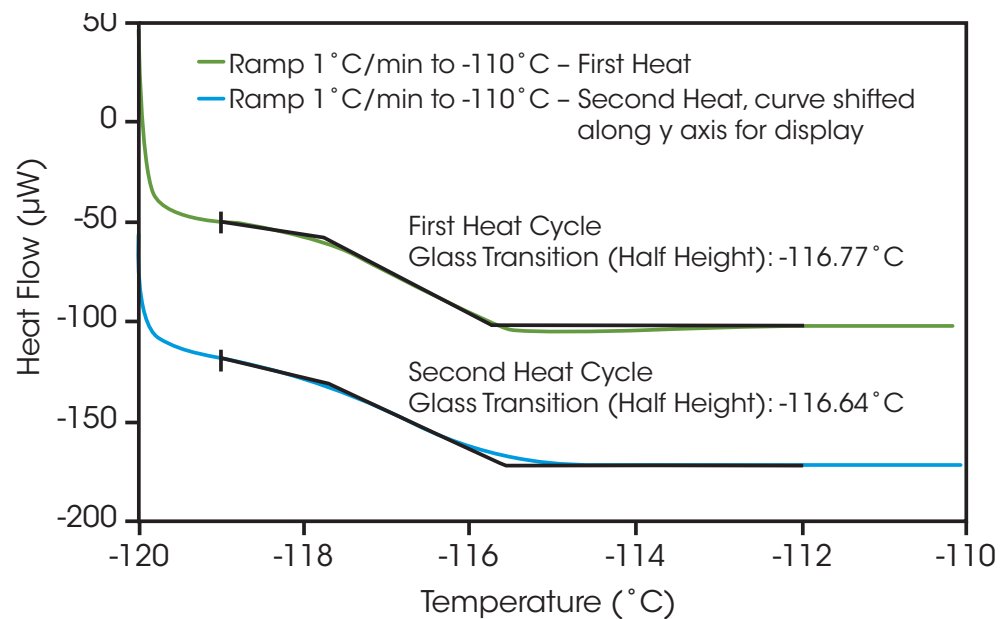

Detecting a Low-Temperature Glass Transition using the RCS 120

The DSC thermogram demonstrates the ease of detecting a very low temperature T_g of a silicone material with the liquid nitrogen-free cooling accessory, the RCS 120.

Controlled Cooling Rate* (from upper limit of the accessory)	RCS 40 To Lower Temperature	RCS 90 To Lower Temperature	RCS 120 To Lower Temperature	LN Pump To Lower Temperature
100°C/min	—	300°C	300°C	200°C
50°C/min	175°C	120°C	175°C	0°C
20°C/min	40°C	-20°C	-10°C	-100°C
10°C/min	0°C	-50°C	-55°C	-150°C
5°C/min	-15°C	-75°C	-80°C	-165°C
1°C/min	-40°C	-90°C	-120°C	-180°C

* Performance may vary slightly, depending on laboratory conditions.

ACCESSORIES | COOLING SYSTEMS

Discovery Liquid Nitrogen Pump Accessory (LN Pump)

The LN pump provides the highest performance and greatest flexibility in cooling for the Discovery DSC. It facilitates the lowest operational temperature (to -180°C), greatest cooling rate capacity (to $140^{\circ}\text{C}/\text{min}$), fastest sub-ambient equilibration times, and an upper temperature limit of 550°C . Operating at ambient pressure, the LN Pump uses liquid nitrogen efficiently, thus reducing operating costs. It includes a 50-liter Dewar with auto-fill capability which allows the LN Pump to be automatically refilled from a larger source, even during a DSC experiment, for continuous DSC operation with no disruption.

Finned Air Cooling System (FACS)

The FACS is an innovative cooling accessory that offers a cost-effective alternative to the RCS or LN Pump cooling systems. The FACS can be used for controlled cooling experiments, thermal cycling studies, and to improve sample turnaround time. Stable baselines and linear heating and cooling rates can be achieved between ambient and 725°C . The FACS can be used with the Quench Cooling Can to quickly cool the cell to room temperature at the end of a test for faster sample turnaround.

Quench Cooling Accessory (QCA)

The Quench Cooling Accessory (QCA) is a manual cooling accessory for TA DSCs. It is a cost effective alternative to refrigerated and liquid nitrogen cooling systems. The QCA is commonly used to rapidly cool the cell to sub-ambient temperatures and for improving turnaround times by quickly cooling the cell to ambient temperature. It can also be used for programmed cooling experiments. The QCA reservoir is easily filled with ice, ice / water, dry ice, liquid nitrogen or other cooling mediums. Linear heating and cooling rates can be achieved from -180 to 550°C .

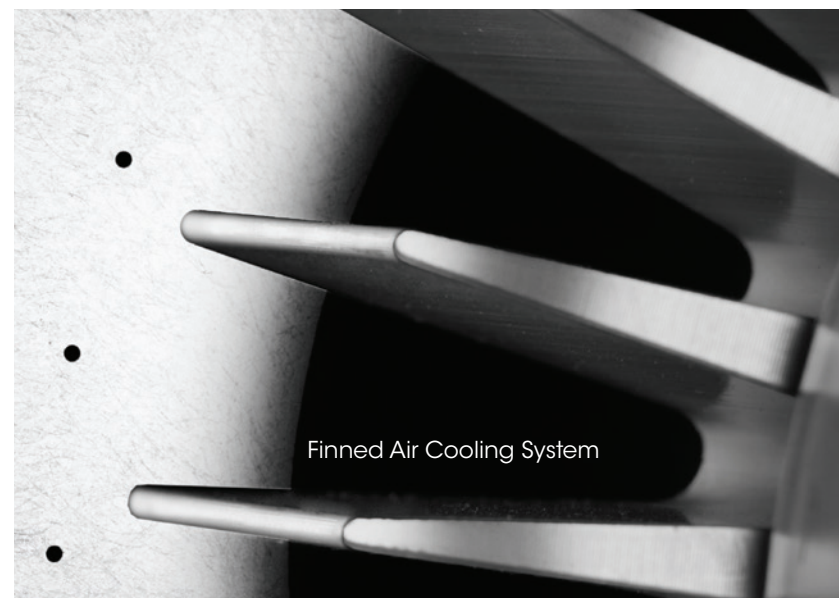

Explore the full line of
INTERCHANGEABLE COOLING SYSTEMS
designed and manufactured
by TA Instruments for our **DSCs**

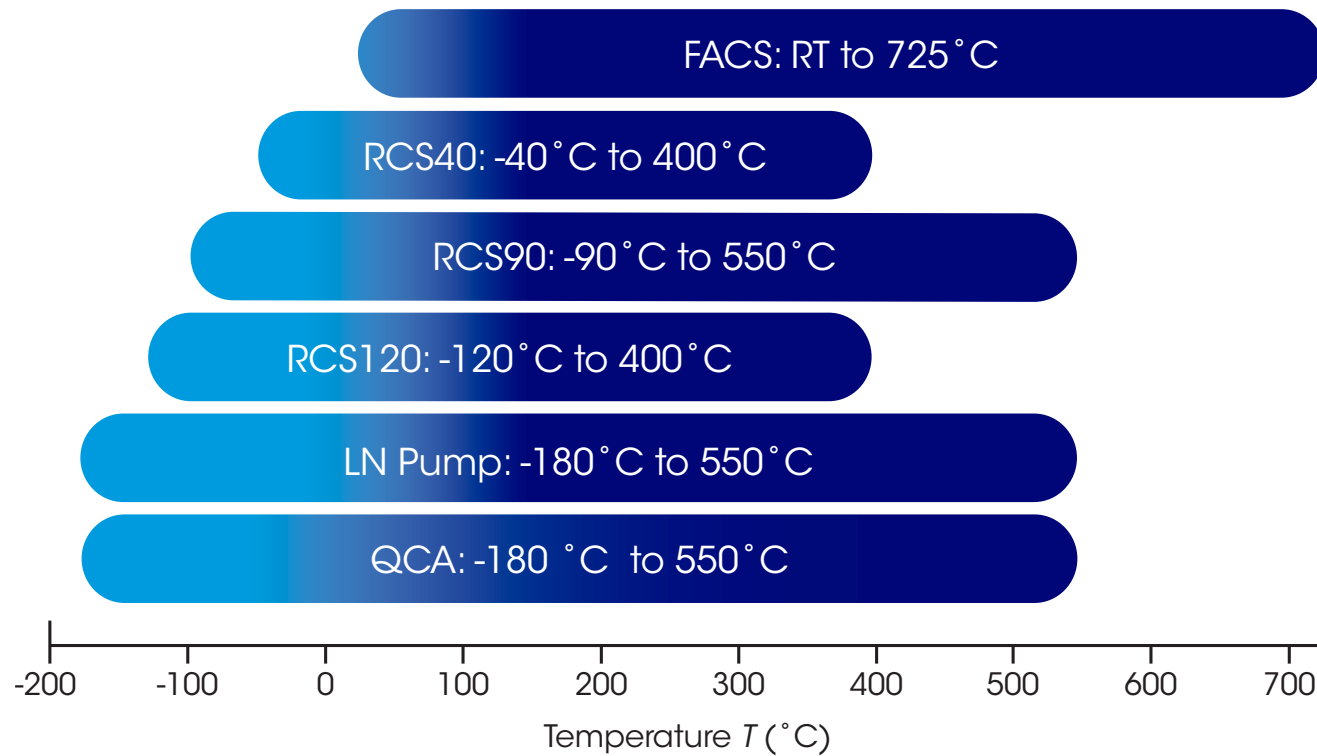

ACCESSORIES | TZERO® PRESS & PANS

Proper sample preparation is of critical importance to the quality of data generated on a DSC. The Tzero sample encapsulation press and pans take into consideration every detail necessary by design to ensure simple and proper preparation for the highest data quality.



Tzero Pans

Tzero high-performance pans and lids are designed to maximize pan flatness and sample contact. Coupled with the unparalleled flatness and uniformity of the Fusion Cell™ sensor, the Tzero pans and lids provide the most direct, uniform heat flow path from the sample to the sensor. These pans are tolerant of many sample forms and are designed with lids that conform to the top of irregular specimens, efficiently transferring heat to and from the entire sample. Competitive pan designs that have non-flat bases are unable to achieve appropriate thermal contact with solid specimens. Fabricated using advanced technology and to extremely tight tooling specifications, the Tzero pans offer significant improvements in resolution and repeatability over any other pan design.

Tzero DSC Sample Encapsulation Press

The Tzero press takes sample encapsulation to a higher level of performance and convenience in conventional and hermetic sealing of a wide variety of materials. The press kit includes four die sets for Tzero aluminum and hermetic pans & lids. Optional die sets are available for high-volume DSC pans and Discovery TGA sealed pans. The die sets are magnetically attached with no tools or adjustments required. In addition, each die set is color-coded to the box containing the compatible Tzero or standard aluminum hermetic pans and lids.

TA offers a pan for every application

	Temperature Range	Comments
Tzero® Aluminum	-180°C to 600°C	High performance pans
Tzero Hermetic Aluminum		Hermetic pans for pressures up to 300 kPa (3 atm)
Tzero Low-Mass Aluminum		High performance pans for thin samples
Aluminum		Good performance pans
Aluminum hermetic		Hermetic pans for pressures up to 300 kPa (3 atm)
SFI Aluminum (Solid Fat Index)		Designed for evaluating edible fats and oils
Gold	-180°C to 725°C	Used if the sample reacts with Aluminum
Gold hermetic		Hermetic pans for pressures up to 600 kPa (6 atm)
Copper		Used for oxidative experiments
Platinum		Used if the sample reacts with Aluminum
Graphite		Used for materials that might alloy with various metals
Alodined aluminum hermetic	-180°C to 200°C	Hermetic pans for aqueous solutions
Tzero Hermetic Aluminum Alodined		
High volume pans (Stainless Steel)	-100°C to 250°C	100 µL pans that suppress vaporization up to 250°C
High pressure capsules (Stainless Steel)	Ambient to 300°C	Reusable Hermetic pans for up to 1450 psi

ACCESSORIES | OPTICAL

Microscope Camera

DSC thermograms can sometimes be complicated and difficult to interpret. On occasion, multiple DSC experiments must be performed to better understand a thermal event. The Discovery™ DSC Microscope Accessory allows you to view the sample while performing a DSC experiment. Easily identify an endothermic solid-solid phase transition that may erroneously be interpreted as a melting endotherm with the Microscope camera. Also observe physical changes in a material as it undergoes phase transitions and volumetric dimensional changes, such as shrinkage, associated with a transition, evaporation or sublimation.

The Discovery DSC Microscope Accessory is a high resolution digital microscope camera which simultaneously captures images and video during a DSC experiment. It has a temperature range of -180 °C to 725 °C and is compatible with the FACS, LN Pump, and RCS 40, 90 and 120 cooling accessories by TA Instruments.



Optical Accessory Kit

The Optical Accessory Kit provides the capabilities for measuring the calorimetric characteristics of a sample, such as heat flow and heat capacity, while simultaneously collecting information on the optical characteristics, such as RAMAN, Near-IR and visible changes in the sample. Such measurements can provide information on the chemical or structural changes that are occurring within a material that is complementary to the heat flow data collected by the DSC. A specially designed cell lid assembly allows for direct observation of the sample by the external optical probe while maintaining high-quality calorimetric performance. This flexible interface can be configured to work with many optical systems through the use of an appropriate probe adapter that may be supplied by 3rd-party vendors.



Photocalorimeter

The Photocalorimeter Accessory (PCA) permits characterization of photocuring materials between -50 and 250 °C. UV/Visible light (320-500 nm) from a 200 W high pressure mercury source is transmitted to the sample chamber via an extended range, dual-quartz light guide with neutral density or band pass filters. TZero™ Technology permits direct and accurate measurement of light intensity at both the sample and reference positions without the need for an external radiometer. It also allows simultaneous measurement of two samples.

LED Photocalorimeter

The LED photocalorimeter accessory (LED-PCA) permits the study and characterization of photocurable materials from -50 to 250 °C while eliminating the need for mercury lamps. Light Emitting Diodes (LEDs) deliver precise wavelengths of the user's choice among 365nm, 385nm, 395nm, and 405nm of intensity from 5 mW/cm² to >10 W/cm² with a typical range being from 10-100 mW/cm². Intensity is controlled by the output power of the OmniCure™ LX500 Source and up to two neutral density filters. Final intensities of the light at the sample and reference positions are matched with fine-tuning screws on the accessory itself. Unlike the PCA capabilities of some competitors, TZero™ Technology by TA Instruments allows for real-time direct measurement and matching of the UV light intensity at both the sample and reference positions. This helps eliminate the need for an external radiometer and helps ensure that the light intensity is the same or similar throughout the course of many measurements.



Choosing the
BEST DSC for
YOUR NEEDS



Instrument Features	DSC25	DSC250	DSC2500
Fusion Cell™	●	●	●
MDSC®	●	●	●
Standard Heat Flow	●	●	●
Tzero® Heat Flow	—	●	●
Advanced Tzero Heat Flow (T4P)	—	—	●
Direct Cp Measurement	—	—	●
User Replaceable Cell	●	●	●
54-Position Autosampler	○	○	●
Dual Input Gas-Delivery Manifold	●	●	●
Color App-Style Touch Screen	●	●	●
Photocalorimeter	—	○	○
Microscope Camera	○	○	○
Optical Accessory Kit	○	○	○
Specification			
Baseline Flatness (-50 to 300°C) ^[1]	<100 μW	≤10 μW	≤5 μW
Baseline Repeatability (-50 to 300°C)	<40 μW	<20 μW	<10 μW
Temperature Range	-180°C to 725°C	-180°C to 725°C	-180°C to 725°C
Temperature Accuracy	±0.1°C	±0.05°C	±0.025°C
Temperature Precision	±0.01°C	±0.008°C	±0.005°C
Enthalpy Precision	±0.1%	±0.08%	±0.04%

● Included

○ Optional

— Not Available

^[1] No baseline subtractions

DISCOVERY DSC 25P | PRESSURE DIFFERENTIAL SCANNING CALORIMETER



The DSC 25P is a dedicated Pressure DSC that provides heat flow measurements on pressure sensitive materials. The Discovery DSC 25P is used to study thermal transitions, chemical reactions, oxidative stability and decomposition under vacuum, atmospheric pressure and elevated pressures.

The DSC 25P has a pressure range of 1 Pa to 7 MPa (0.0001 to 1,000 psi), of which experiments can be performed under static or dynamic purge (constant volume or constant pressure). It is compatible with a variety of inert, oxidizing, or reducing atmospheres for unparalleled flexibility in handling the most demanding DSC applications.

The Discovery DSC 25P can operate under atmospheric and elevated pressures from ambient to 550°C. The optional Quench Cooling Accessory extends the operational range to sub-ambient experimental temperatures as low as -130°C.

Discovery Pressure DSC 25P Features and Benefits:

- Fusion Cell™ with a pressure transducer, fixed-pedestal mounted sensor, rugged silver furnace, Tzero® thermocouple, and temperature controlled electronics. The design of the DSC 25P Fusion Cell™ ensures accurate temperature control and stable heat flow baseline performance
- Modulated DSC® (MDSC®) under elevated pressures for efficient separation of complex thermal events and monitoring changes in heat capacity
- Pressure and flow control is easier than ever with conveniently located flow control valves
- One-Touch-Away™ user interface provides accessible monitoring of real-time signals such as pressure, temperature, and time
- Powerful and intuitive TRIOS software simplifies instrument control and data analysis

DISCOVERY DSC 25P | PRESSURE DSC APPLICATIONS

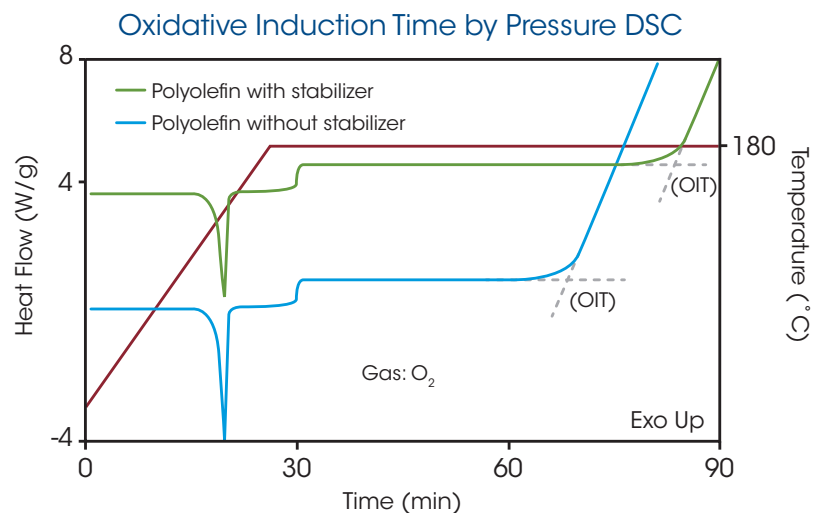

Oxidative induction time analysis (OIT, oxidative stability) has found widespread use as a quality control in determining a material's oxidative stability. The useful lifetime of a product is often related to its resistance to oxidative degradation. OIT analysis is an accelerated thermal-aging test and the data generated provides a qualitative assessment of the material tested. It is determined by the thermo-analytical measurement of the time interval to the onset of exothermic oxidation at a specified temperature in an aerobic atmosphere. The onset of oxidation is signaled by an abrupt increase in the sample's evolved heat. A material's chemistry, the antioxidant additive, and operational or process temperature all influence a material's susceptibility to oxidation.



Pressure and Atmosphere

Pressure Range

Vacuum (1 Pa) to 7 MPa (1,000 psi)

Atmosphere

Nitrogen, Helium, Argon, Carbon Dioxide, Air, Oxygen, Hydrogen

Temperature

Temperature Range (Nitrogen, Argon, Oxygen, Air, or CO₂)

Ambient to 550°C, -130 to 550°C with cooling accessory

Temperature Range (Helium, Hydrogen)

Up to 350°C

Heating Rate

0.01 to 100°C/min

Temperature Accuracy

+ 0.1°C

Calorimetry

Dynamic Heat Flow Range

± 500 mW

Calorimetric Reproducibility

± 1% (based on metal standards)



AMERICAS

New Castle, DE USA

Lindon, UT USA

Eden Prairie, MN USA

Chicago, IL USA

Costa Mesa, CA USA

Montreal, Canada

Toronto, Canada

Mexico City, Mexico

São Paulo, Brazil

EUROPE

Hüllhorst, Germany

Eschborn, Germany

Elstree, United Kingdom

Brussels, Belgium

Eftten-Leur, Netherlands

Paris, France

Barcelona, Spain

Milano, Italy

Warsaw, Poland

Prague, Czech Republic

Solna, Sweden

Copenhagen, Denmark

ASIA & AUSTRALIA

Shanghai, China

Beijing, China

Tokyo, Japan

Seoul, South Korea

Taipei, Taiwan

Guangzhou, China

Petaling Jaya, Malaysia

Singapore

Bangalore, India

Sydney, Australia



TA Instruments and Waters are trademarks of Waters Corporation.
All other trademarks are the property of their respective owners.

©2024 Waters Corporation. All rights reserved.
July 2024 TA00001EN-A4 Rev. A

TA Instruments
159 Lukens Drive
New Castle, DE 19720 U.S.A.
T: 1 302 427 4000
F: 1 302 427 4041
www.tainstruments.com

Waters Corporation
34 Maple Street
Milford, MA 01757 U.S.A.
T: 1 508 478 2000
F: 1 508 872 1990
www.waters.com